

HEADLESS TYPE RESISTANCE THERMOMETERS

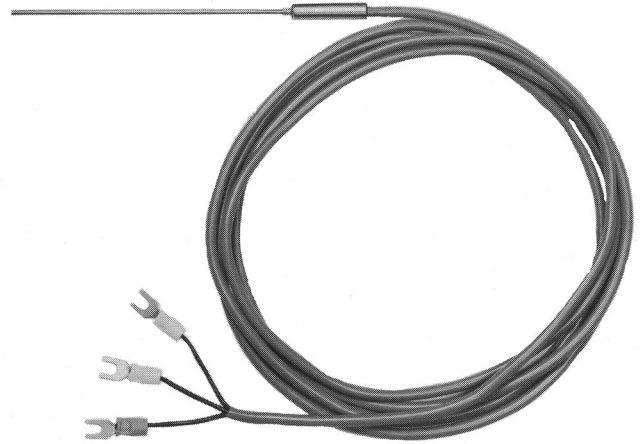

- MODEL R 005 (General type)
- R 040 (Superfine type)
- R 003 (Ultrafine type)
- R 900, 902 (Submersible type)
- R 903 (Buried type)

These sensors are headless type platinum resistance thermometers and are available in five types, i.e., general type, superfine types, ultrafine type, submersible type and buried type.



MODEL R 040



MODEL R 005-111



MODEL R 005-141



MODEL R 900

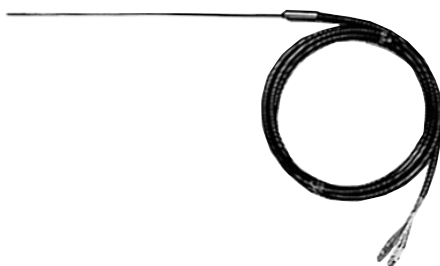

MODEL R 003



MODEL R 903

HEADLESS TYPE RESISTANCE THERMOMETERS

GENERAL TYPE

- MODEL R 005** - □1□ (Standard type)
 - □2□ (Heat resistant type)
 - □31 (Quick response type)
 - □41 (Waterproof type)
- Tip Type
 1: Closed
 2: Open
- ELEMENT
 1: JPt100
 3: Pt100



MODEL R 005-111 (Closed tip type)



MODEL R 005-141 (Waterproof type)

This sensor is headless type platinum resistance thermometers and is available in four types, i.e., general type, heat resistant type, quick response type and waterproof type.

GENERAL SPECIFICATIONS

- Element: Pt100, JPY100 (100Ω at 0°C)
 three wire type
- Rated current: PT100 (φ1.0 1mA, φ1.6 2mA),
 JPY100 (class B 5mA, class A 2mA)
- Class: JIS class B, class A
- Range: Standard & Heat Resistant Type ...
 0 to 350°C
 Quick Response & Waterproof type ...
 (-)50 to 150°C
- Dia. of protective tube: φ6,
 except Quick Response Type is φ3.2
- Length of protective tube: 100, 200, 300, 500 mm
- Material of protective tube: SUS304 (standard), SUS316, titanium, etc.
- Sleeve part heat resistant temp.:
 60°C,
 except Heat Resistant Type is 200°C

EXTERNAL DIMENSIONS

● Closed tip type (R005-□11, □21, □31)

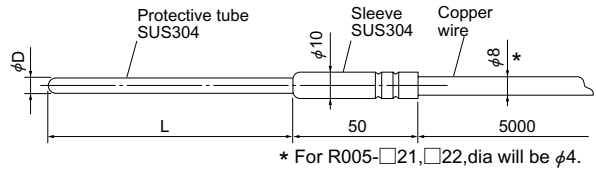

● Open tip type (R005-□12, □22)

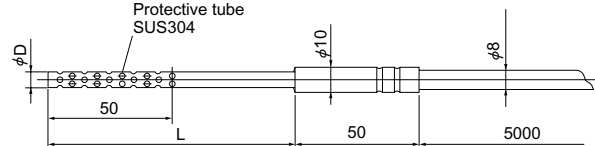

● Closed tip type (R005-□11, □21, □31)

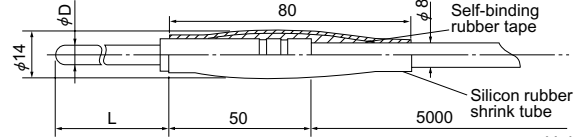

Unit : mm

MODELS

Name	Model (above Pt100, below JPt100)	Product Code (Pt100 only)	Tip Shape	Protection Tube	Lead Wire	Length (L) mm
Standard Type	R005-311 R005-111	1YRF611	Closed Type	SUS304, φ6	Vinyl covered wire 5m	100
		1YRF612				200
		1YRF613				300
		1YRF615				500
	R005-312 R005-112	1YRF711	Open Type	SUS304, φ6	Vinyl covered wire 5m	100
		1YRF712				200
1YRF713		300				
1YRF715		500				
Heat Resistant Type	R005-321 R005-121	1YRF621	Closed Type	SUS304, φ6	Polyimide and glass wool braided wire 5m	100
		1YRF622				200
		1YRF623				300
		1YRF625				500
	R005-322 R005-122	1YRF721	Open Type	SUS304, φ6	Polyimide and glass wool braided wire 5m	100
		1YRF722				200
		1YRF723				300
		1YRF725				500
Quick Response Type	R005-331 R005-131	1YRF631	Closed Type	SUS304, φ3.2	Vinyl covered wire 5m	100
		1YRF632				200
		1YRF623				300
Waterproof Type	R005-341 R005-141	1YRF641	Closed Type	SUS304, φ6	Vinyl covered wire 5m	100
		1YRF642				200
		1YRF643				300
		1YRF645				500

RESPONSE

Diameter	Condition	Room temp. → 100°C (boiling water)
φ3.2 (Closed Type)		17.5.sec (90%)
φ6 (Closed Type)		41.3.sec (90%)

SUPERFINE TYPE

MODEL R 040 -□1

-□2

Element
1: JPt100
3: Pt100

This is a temperature sensor that employs a superfine platinum resistance thermometers elements and is suitable for accurate temperature measurements in performance tests of heat exchangers.

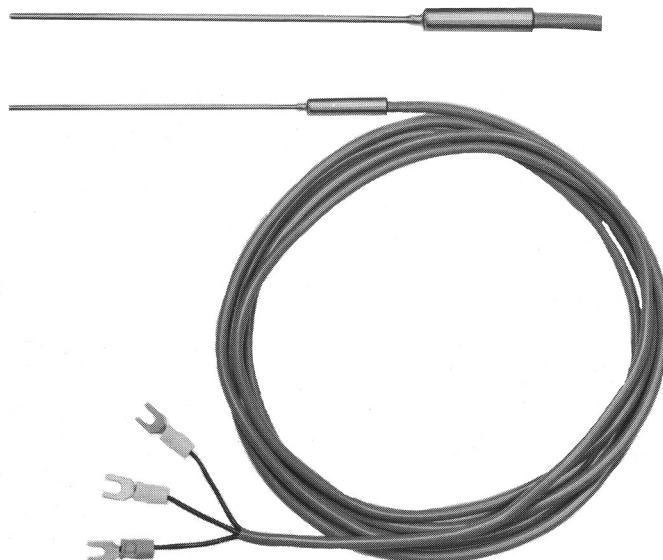

MODEL R 040

GENERAL SPECIFICATIONS

Element:	Pt100, JPt100 (100Ω at 0°C) three-wire type
Rated current:	Pt100 (2mA, 1mA), JPt100 (5mA, 2mA)
Class:	JIS Class B, Class A
Range:	(-)50 to 100°C
Dia.of protective tube:	φ2
Length of protective tube:	100mm or 200mm
Material of protective tube:	SUS304
Lead wire:	Material Soft polyvinyl covered wire Diameter..... φ3.8 Length 3m (standard)
Response:	Room temp.→Boiling Water (100°C) ... About 3.5 sec. (90%)

EXTERNAL DIMENSIONS

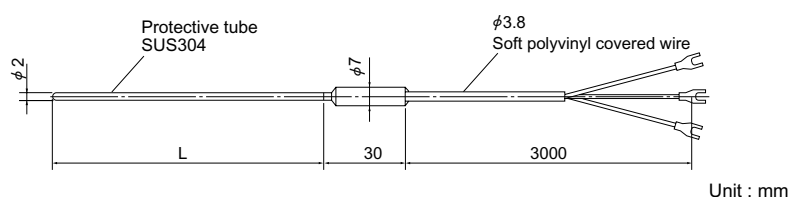

MODELS

Model (above Pt100, below JPt100)	Product Code	Specification
R040-31	1YRG531	dia. 2mm x length 100mm, with lead wire WY34 3m
R040-11	1YRG031	
R040-32	1YRF532	dia. 2mm x length 200mm, with lead wire WY34 3m
R040-12	1YRF032	

HEADLESS TYPE RESISTANCE THERMOMETERS

ULTRAFINE TYPE

MODEL R 003 - 1

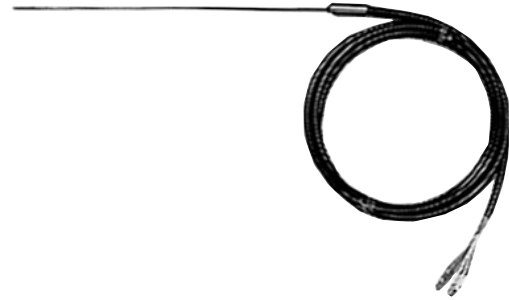
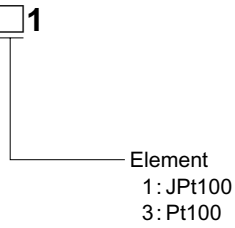

MODEL R 003

This is a temperature sensor that has very thin protective tube so suitable for accurate temperature measurement such as minor temperature changes.

GENERAL SPECIFICATIONS

Element:	Pt100, JPY100 (100Ω at 0°C) three wire type
Rated current:	PT100 (2mA, 1mA), JPY100 (5mA, 2mA)
Class:	JIS class B, class A
Range:	(-) 50 to 200°C
Material of protective tube:	SUS316
Length of protective tube:	100, 200mm
Lead wire:	Material... Cold-resistant vinyl (WY34) Length ... 3m
Response:	φ1.0, Room temp.→Boiling Water (100°C) ... About 1.5 sec.

EXTERNAL DIMENSIONS

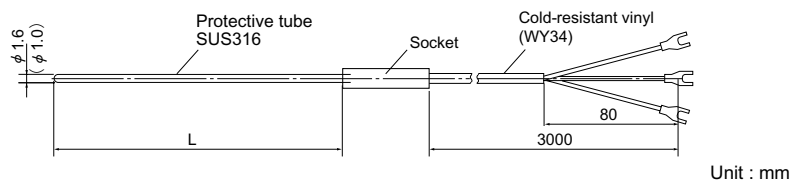

MODELS

Model (above Pt100, below JPt100)	Product Code	Protective Tube diameter & material	Lead Wire
R003-3	1YRP631	φ1.0, SUS316	WY 3m
	1YRP632		
R003-1	1YRP731	φ1.6, SUS316	WY 3m
	1YRP732		

SUBMERSIBLE TYPE

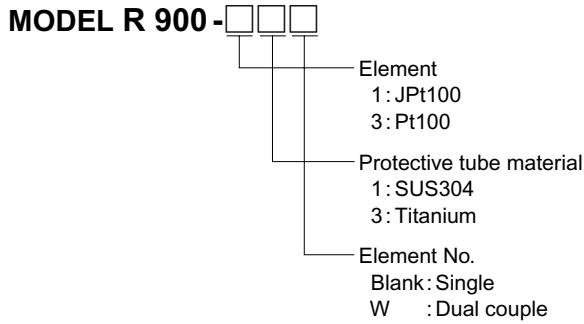

MODEL R 900

This is a resistance thermometer that can be immersed directly into water for temperature measurements. It is completely waterproof.

GENERAL SPECIFICATIONS

Element:	Pt100, JPt100 (100Ω at 0°C) three-wire type
Rated current:	Pt100 (2mA, 1mA), JPt100 (5mA, 2mA)
Class:	JIS Class B, Class A
Range:	(-)50 to 150°C
Dia. of protective tube:	R900 single type φ6, Dual type φ8 R902 φ8
Length of protective tube:	100mm or 200mm
Material of protective tube:	SUS304
Lead wire:	Material... Soft Cold-resistant polyvinyl covered polyvinyl covered wire (-) 40 to 60°C (WY36) Neoprene rubber wire (-) 40 to 70°C (WN61)
Diameter:	φ6, φ8, φ10 (dualcouple)
Length:	5m (standard)
Response:	Room temp. → Boiling Water (100°C) ... About 50 sec.

EXTERNAL DIMENSIONS

● Single type (R900-□□□)

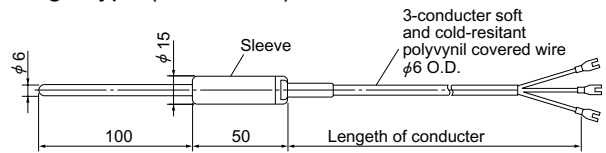

● Dualcouple type (R900-□□□W)

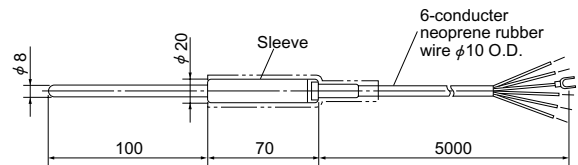

● Single type without sleeve (R902-□□□)

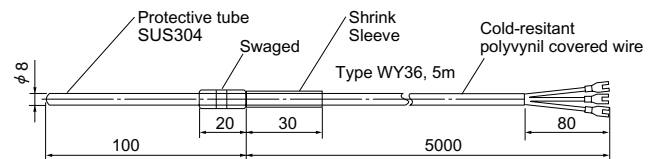

Unit : mm

MODELS

Name	Model (above Pt100, below JPt100)	Product Code (Pt100 only)	Protection Tube	Lead Wire	Length (L) mm
Single Type	R900-11 R900-31	1YRM651	SUS304	WY36 5m	100
		1YRM611		WY36 10m	
	R900-12 R900-32	1YRM652	Titanium	WY36 5m	
		1YRM612		WY36 10m	
Dualcouple Type	R900-11W R900-31W	1YRM751	SUS304	WN61 5m	100
		1YRM711		WN61 10m	
	R900-12W R900-32W	1YRM752	Titanium	WN61 5m	
		1YRM712		WN61 10m	
Single Type without sleeve	R902-31 R902-11	—	SUS304	WY36 5m	100
		—			

BURIED TYPE

MODEL R 903

This is a resistance thermometer that can be buried in soil for measurements of temperature. It is both vibration-proof and waterproof.



MODEL R 903

GENERAL SPECIFICATIONS

Element: Pt100, JPt100 (100Ω at 0°C)
three-wire type
Rated current: Pt100 (2mA, 1mA), JPt100 (5mA, 2mA)
Class: JIS Class B, Class A
Range: (-)50 to 150°C
Material of protective tube: SUS304
Lead wire: Material 3-conductor or 6-conductor
lead sheathed neoprene
rubber (WL31 / WL61)
neoprene rubber
(WN38 / WN61)
(max. 70°C)
Diameter..... φ10
Length 5m (standard)

EXTERNAL DIMENSIONS

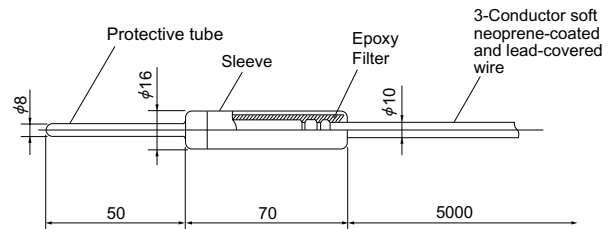

Unit : mm

MODELS

Name	Model (above Pt100, below JPt100)	Product Code (Pt100 only)	Protection Tube	Lead Wire	Length (L) mm
Single Type	R903-3L R903-1L	1YRN610	SUS304	WL31 5m	50
	R903-3N R903-1N	1YRN620		WN38 5m	
Dualcouple Type	R903-3WL R903-1WL	1YRN210		WL61 5m	
	R903-3WN R903-1WN	1YRN220		WN61 5m	

Specifications subject to change without notice. Printed in Japan (I) 2011. 7

CHINO CORPORATION

32-8 KUMANO-CHO, ITABASHI-KU, TOKYO 173-8632
Telephone : +81-3-3956-2171
Facsimile : +81-3-3956-0915
E-mail : inter@chino.co.jp
Website : www.chino.co.jp/